

# The Conservation Rooflight® On the Rafter Roof Window Sizes

Before selecting your size, carefully read the 'Installation Overview' PDF.



## Structural Area



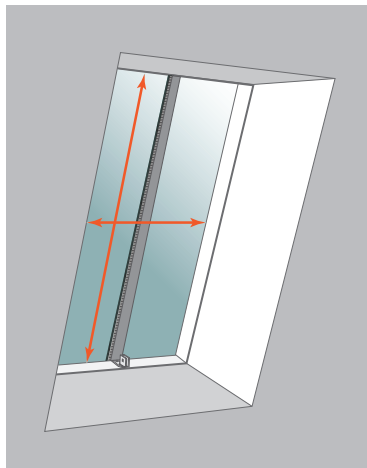





The internal perimeter of the aperture - the frame for the roof window. Please measure the width and length of the edge of the rafters.

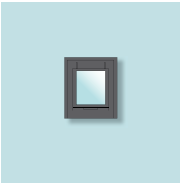
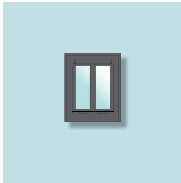
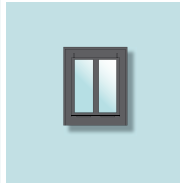
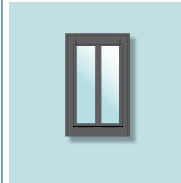
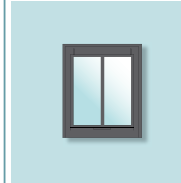
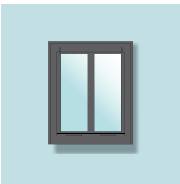

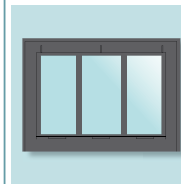

## Viewable Area

The area of glass that is viewable from inside the room. Please measure the width and length at its closest point to the glass.

## Conservation Rooflights®

<p><b>Structural dimensions</b> 412mm x 520mm</p>  <p><b>Viewable dimensions</b> 212mm x 320mm <b>CR6 - £435</b></p>	<p><b>Structural dimensions</b> 463mm x 622mm</p>  <p><b>Viewable dimensions</b> 263mm x 422mm <b>CR7 - £450</b></p>	<p><b>Structural dimensions</b> 565mm x 725mm</p>  <p><b>Viewable dimensions</b> 365mm x 525mm <b>CR1 - £460</b></p>	<p><b>Structural dimensions</b> 565mm x 1028mm</p>  <p><b>Viewable dimensions</b> 365mm x 828mm <b>CR3 - £495</b></p>	<p><b>Structural dimensions</b> 615mm x 875mm</p>  <p><b>Viewable dimensions</b> 415mm x 675mm <b>CR8 - £535</b></p>
<p><b>Structural dimensions</b> 717mm x 1028mm</p>  <p><b>Viewable dimensions</b> 517mm x 828mm <b>CR9 - £585</b></p>	<p><b>Structural dimensions</b> 717mm x 1180mm</p>  <p><b>Viewable dimensions</b> 517mm x 980mm <b>CR10 - £630</b></p>	<p><b>Structural dimensions</b> 717mm x 1333mm</p>  <p><b>Viewable dimensions</b> 517mm x 1133mm <b>CR14/2 - £680</b></p>	<p><b>Structural dimensions</b> 717mm x 1635mm</p>  <p><b>Viewable dimensions</b> 517mm x 1435mm <b>CR15/2 - £795</b></p>	<p><b>Structural dimensions</b> 1021mm x 725mm</p>  <p><b>Viewable dimensions</b> 821mm x 525mm <b>CR1/3 - £610</b></p>
<p><b>Structural dimensions</b> 869mm x 1028mm</p>  <p><b>Viewable dimensions</b> 669mm x 828mm <b>CR11 - £650</b></p>	<p><b>Structural dimensions</b> 1021mm x 1180mm</p>  <p><b>Viewable dimensions</b> 821mm x 980mm <b>CR13 - £755</b></p>	<p><b>Structural dimensions</b> 1021mm x 1333mm</p>  <p><b>Viewable dimensions</b> 821mm x 1133mm <b>CR14 - £795</b></p>	<p><b>Structural dimensions</b> 1021mm x 1635mm</p>  <p><b>Viewable dimensions</b> 821mm x 1435mm <b>CR15 - £965</b></p>	

## Egress Conservation Rooflights®

<p><b>Structural dimensions</b> 888mm x 1114mm</p>  <p><b>Viewable dimensions</b> 537mm x 848mm <b>E1LG - £795</b></p>	<p><b>Structural dimensions</b> 888mm x 1114mm</p>  <p><b>Viewable dimensions</b> 537mm x 848mm <b>E1RG - £795</b></p>
--	---

Prices exclude VAT, opening options, accessories and delivery.